

Room thermostat with 24-hour time switch and large LCD

RDJ100



Programmable, for heating systems

- Operating modes: Automatic, Comfort, Energy saving, and Frost protection
- Large LCD display
- Battery powered: 2 x alkaline type AA batteries, 1.5 V
- TPI control for use with ON/OFF heating systems

Use

The device is used to control the room temperature in heating systems.

Typical applications:

- Homes
- Residential buildings
- Schools
- Offices

The device is used together with the following equipment:

- Thermal valves or zone valves
- Combi boilers
- Gas or oil burners
- Pumps

Functions

Temperature control

The device uses a TPI (Time proportional integral) control algorithm to periodically switch on and off the heating system. The period time and pulse length of the control signal (PWM) are determined by setpoint and the measured room temperature via its built-in sensor.

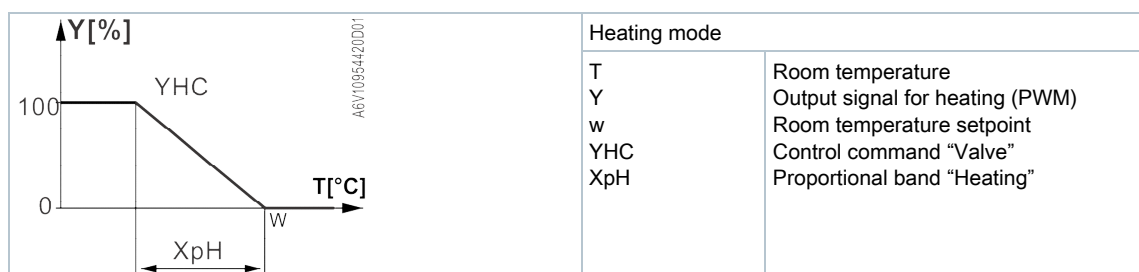









Backup

When removing the batteries, the setpoints and information required for operating mode changeover are retained for max. 2 minutes.

Operating modes

The device has the following modes: Automatic, Comfort, Energy saving and Frost protection. Move the operating mode slider to the respective position to select another operating mode.



Automatic mode	Automatic mode is active when symbol  is displayed. The device operates as the selected 24-hour time program.
Comfort mode	Comfort mode is active when symbol  is displayed. The device controls to the temperature setpoint adjusted at T  . This setpoint can be adjusted by setting the program slider to T  .
Energy saving mode	Energy saving mode is active when symbol  is displayed. The device controls to the temperature setpoint adjusted at T  . This setpoint can be readjusted by setting the program slider to T  .
Frost protection	Frost protection is active when symbol  is displayed. The device controls to the preset temperature setpoint for frost protection.

Display

The digital display shows the current room temperature, the ON/OFF times as well as the symbol for the currently active operating mode which is currently active. When the heating output is active, the triangle symbol is displayed.



Equipment combinations

Description		Product number	Data sheet *)
Electrothermal actuator (for radiator valves)		STA23..	4884
Electrothermal actuator (for small valves 2.5mm)		STP23..	4884

*) The documents can be downloaded from <http://siemens.com/bt/download>.

Ordering

When ordering, specify both name and product number e.g. room temperature controller RDJ100.

Order valves and actuators as separate items.

Mechanical design



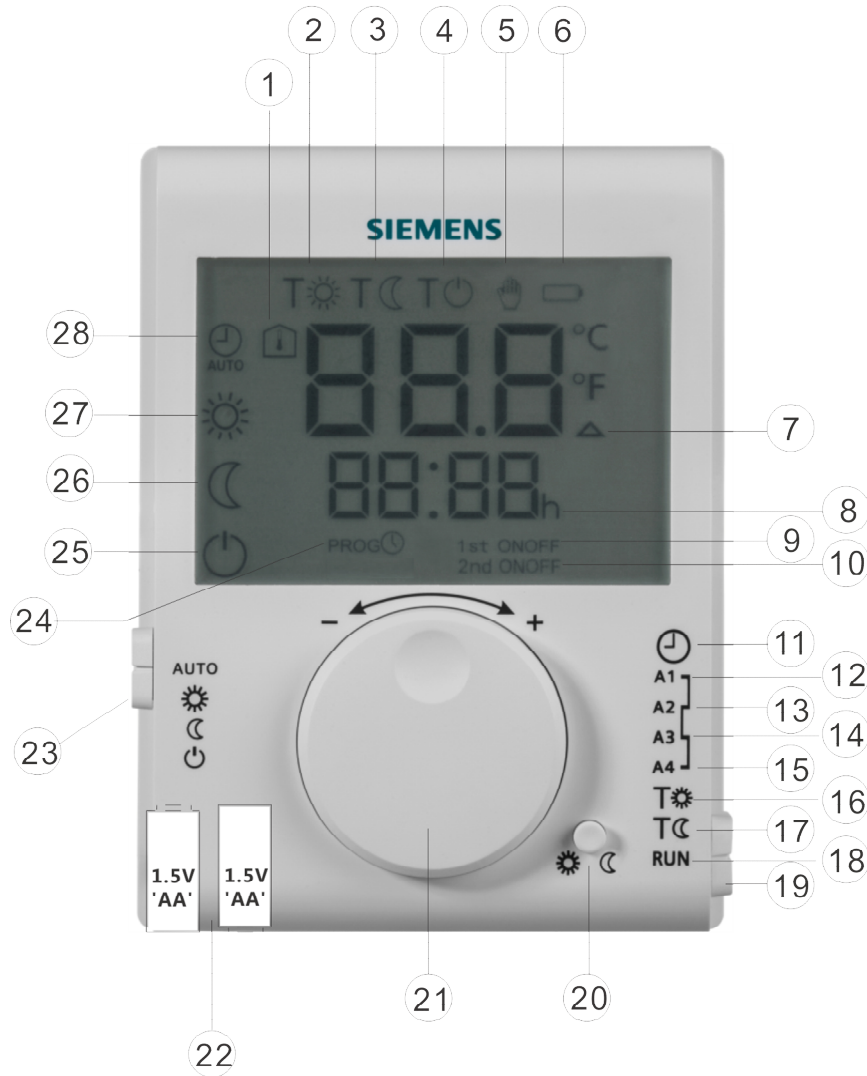

The device consists of 3 parts:

- Plastic housing with digital display containing the electronics, operating elements, and built-in room temperature sensor
- Baseplate (mounting base)
- Battery compartment

The housing engages in the baseplate and snaps on. The baseplate carries the screw terminals. There is a reset button on the rear of the device.



RDJ100 Elements	Functions
1	Room temperature display in °C
2	The device controls to the adjusted comfort temperature setpoint
3	The device controls to the adjusted energy saving temperature setpoint
4	The device controls to the preset frost protection temperature setpoint
5	Setpoint temporarily overridden until the next switching time
6	Indicates low battery power; replace batteries
7	Indicates a heat request
8	Time of day (00:00...23:59 format)
9	Indicates first switch-on/off time
10	Indicates second switch-on/off time

RDJ100 Elements	Functions
11	Time setting position
12	First switch-on time
13	First switch-off time
14	Second switch-on time
15	Second switch-off time
16	Comfort temperature setting
17	Energy saving temperature setting
18	RUN position
19	Program slider
20	Advance button (override / presence button)
21	Temperature setting knob
22	Battery compartment
23	Operating mode slider
24	Indicates that programming is taking place
25	 Frost protection; control to a preset temperature setpoint of 5 °C for frost protection
26	 Energy saving mode; continuous control to the energy saving temperature setpoint
27	 Comfort mode; continuous control to the comfort temperature setpoint
28	 Automatic mode; the device operates as per the selected program

Product documentation

Topic	Title	Document ID:
Operating	Operating instructions	A6V101035986
Installation	Mounting instructions	A6V10974419
CE declaration		A6V101123354

Related documents such as CE declarations, etc., can be downloaded from the following address: <http://siemens.com/bt/download>.

Notes

Disposal



The device is considered an electronics device for disposal in terms of European Directive 2012/19/EU and may not be disposed of as domestic garbage.

- Dispose of the device through channels provided for this purpose.
- Comply with all local and currently applicable laws and regulations.

Mounting

When mounting the device, attach the baseplate first. Then make the electrical connections, and fit and secure the device (refer to the separate mounting instructions A6V10974419). Mount the device on a flat wall and in compliance with local regulations.

If the reference room contains thermostatic radiator valves, set them to their fully open position.

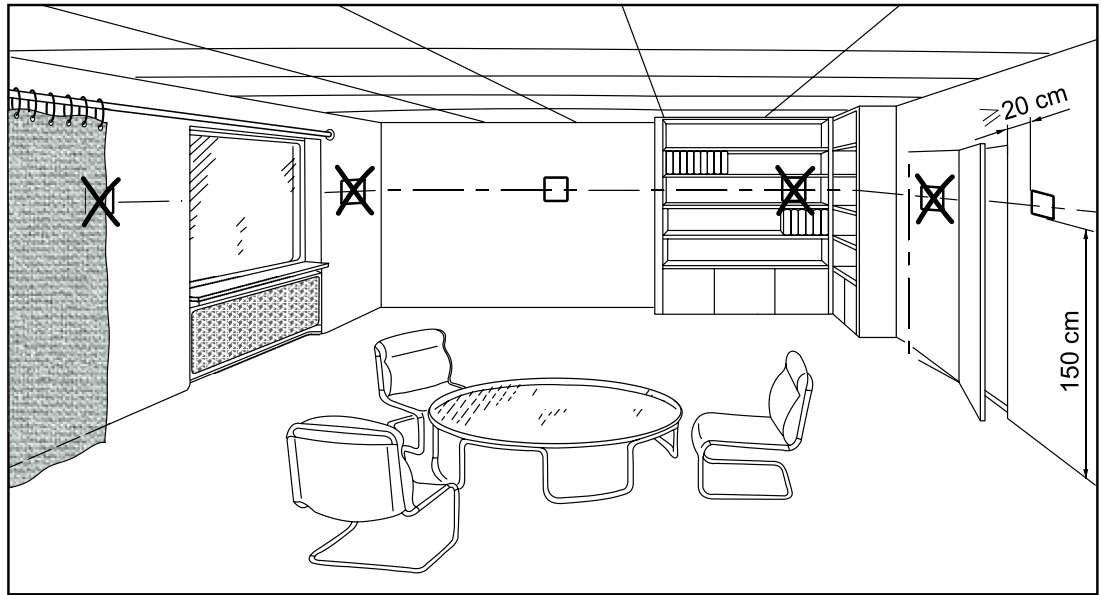

- The devices are suitable for wall mounting.
- Recommended height: 1.5 m above the floor.
- Do not mount the devices in recesses, shelves, behind curtains or doors, or above or near heat sources.
- Avoid direct solar radiation and drafts.
- Seal the conduit box or the installation tube if any, as air currents can affect sensor readings.
- Adhere to allowed ambient conditions.

Installation

	⚠ WARNING
	<p>No internal line protection for supply lines to external consumers. Risk of fire and injury due to short-circuits!</p> <ul style="list-style-type: none">• Adapt the line diameters as per local regulations to the rated value of the installed overcurrent protection device.• The power supply lines must have an external circuit breaker with a rated current of max. 10 A.

Change of batteries

If the battery symbol appears, the batteries are almost empty and must be replaced.

Reset

To reset, press the reset button on the rear of the device. This resets all individual settings to their default values.

Maintenance

The device is maintenance-free.

Technical data

Power supply

Operating voltage	DC 3 V (2 x 1.5 V AA alkaline batteries)
Battery life	>1 year (with AA alkaline batteries)

Internal sensor inputs

Thermistor	10 kΩ ± 1% at 25 °C
------------	---------------------

Switching outputs (Lx, L1, L2)

Relay contacts	Switching voltage	Max. AC 250 V Min. AC 24 V
	Switching current	Max. 5 A res., 2 A ind.
	At AC 250 V	Min. 200 mA
Insulating strength	Between relay contacts and coil	AC 3,750 V
	Between relay contacts (same pole)	AC 1,000 V



⚠ WARNING

No internal fuse

External preliminary protection with max. C 10 A circuit breaker in the supply line required under all circumstances.

Operational data

TPI control:		
Minimum period		12 min
Minimum pulse length		4 min
Setpoint setting range		5...30 °C (Comfort mode) 5...30 °C (Energy saving mode) 5 °C (Frost Protection, fixed value)
Factory setting comfort setpoint		20 °C
Factory setting for energy saving mode		10 °C
Resolution of settings and displays	Temperature setpoint	0.5 °C
	Display of actual temperature value	0.5 °C

Electrical connections

Connections terminals (via baseplate)	Screw terminals
For solid wires	2 x 1.5 mm ²
For stranded wires	1 x 2.5 mm ² (min. 0.5 mm ²)

Environmental conditions	
Operation	IEC 60721-3-3
Climatic conditions	Class 3K5
Temperature	0...+40 °C
Humidity	<90% r.h.
Transport	IEC 60721-3-2
Climatic conditions	Class 2K3
Temperature	-25...+60 °C
Humidity	<95% r.h.
Mechanical conditions	Class 2M2
Storage	IEC 60721-3-1
Climatic conditions	Class 1K3
Temperature	-10...+60 °C
Humidity	<90% r.h.

Standards, directives and approvals	
EU conformity (CE)	A6V101123363 *)
RCM conformity	A6V11161600 *)
Safety class	II as per EN 60730-1
Pollution degree	2
Degree of protection of housing	IP20
Eco design and labeling directives	Based on EU Regulation 813/2013 (Eco design directive) and 811/2013 (Labeling directive) concerning space heaters, the following classes apply: TPI (PWM) room thermostat, for use with On/Off output heaters Class IV Value 2%
Environmental compatibility	The product environmental declaration (A6V101123358 *) contains data on environmentally compatible product design and assessments (RoHS compliance, materials composition, packaging, environmental benefit, disposal).

*) The documents can be downloaded from <http://siemens.com/bt/download>.

General	
Weight (including package)	350 g
Color of housing front	Signal-white RAL9003
Housing material	ABS (LCD lens:PC)

Connection diagram

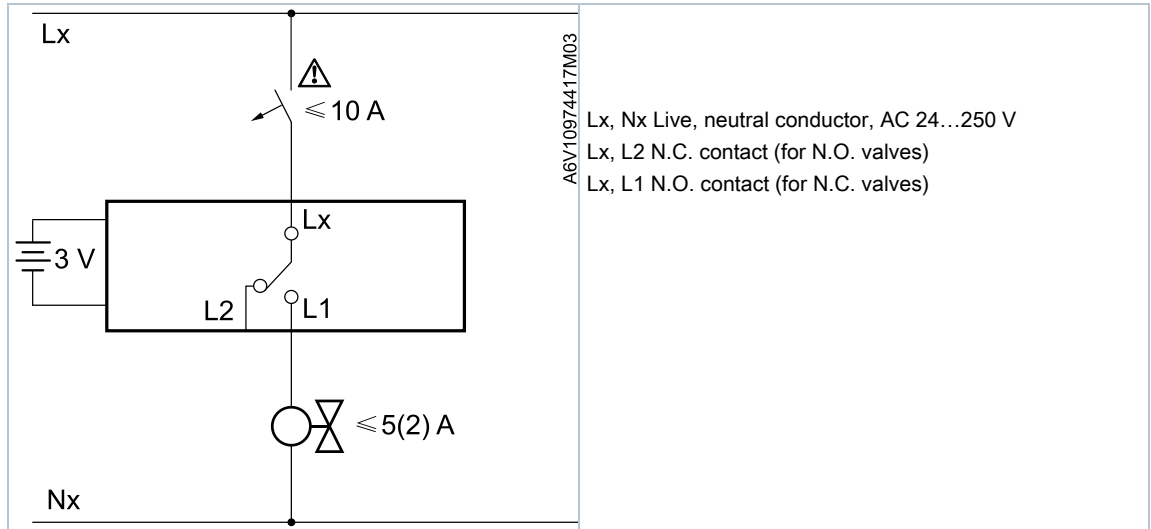

Application examples

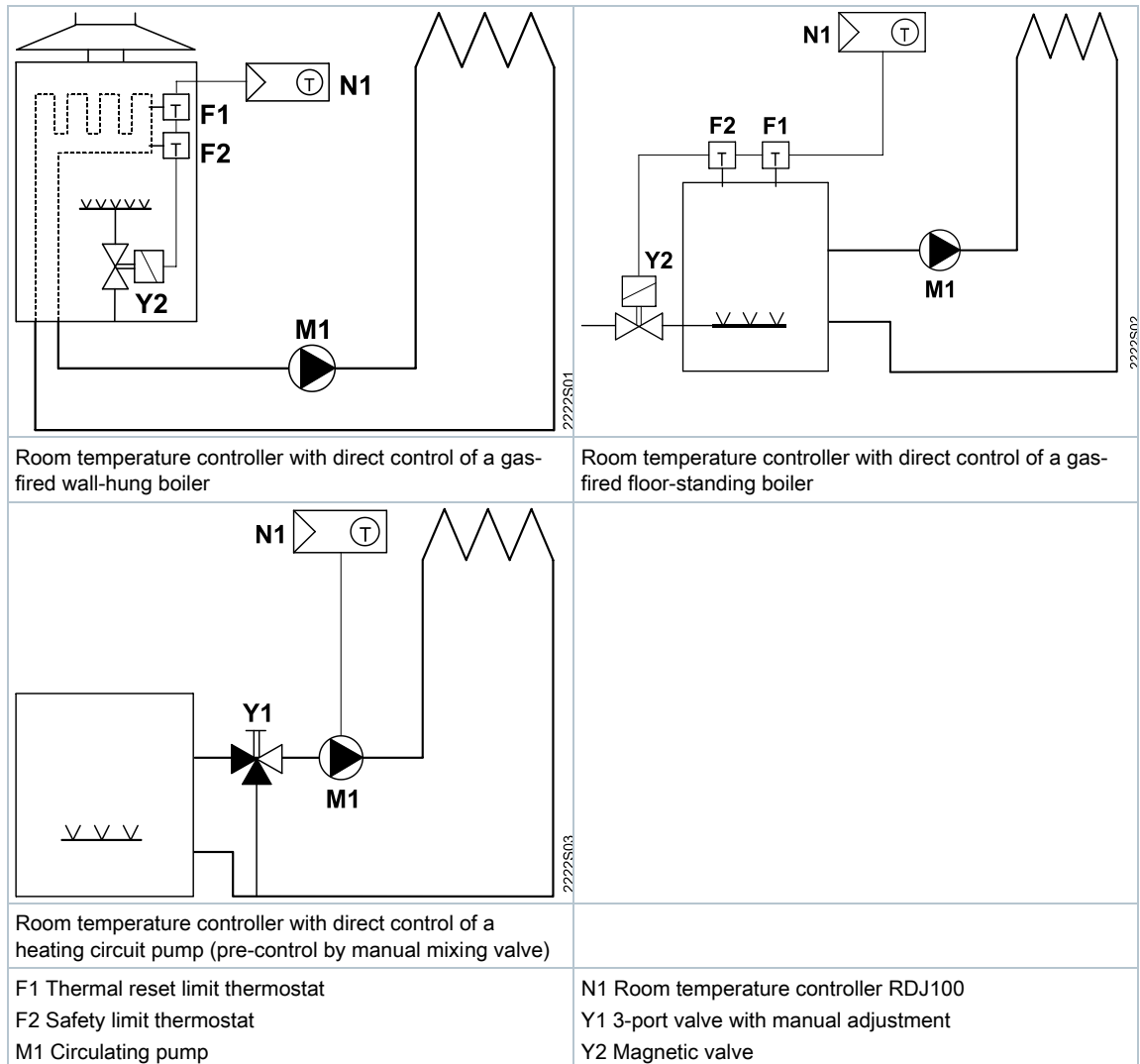

Dimensions

[mm]

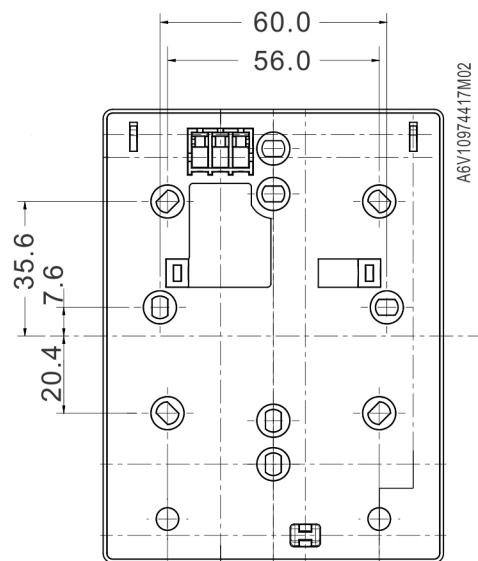
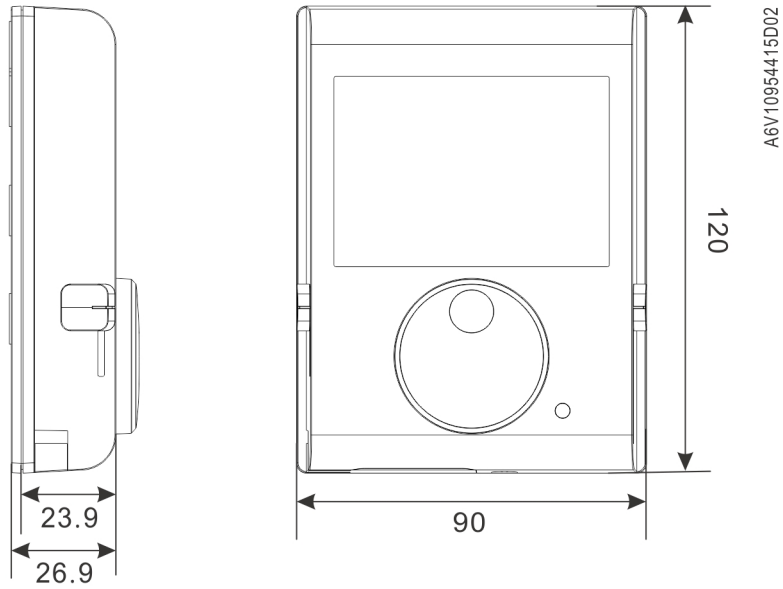

Issued by
Siemens Switzerland Ltd
Building Technologies Division
International Headquarters
Gubelstrasse 22
CH-6301 Zug
Tel. +41 41-724 24 24
www.siemens.com/buildingtechnologies

© Siemens Switzerland Ltd, 2017
Technical specifications and availability subject to change without notice.