



Electro-hydraulic actuators for valves

with a 20 mm stroke

SKB32..
SKB82..
SKB62..
SKB60

- **SKB32..** Operating voltage AC 230 V, 3-position control signal
- **SKB82..** Operating voltage AC 24 V, 3-position control signal
- **SKB6..** Operating voltage AC 24 V, control signal DC 0...10 V, 4...20 mA or 0...1000 Ω
- **SKB6..** Choice of flow characteristic, position feedback, stroke calibration, LED status indication, override control
- **SKB62UA** with functions choice of direction of operation, stroke limit control, sequence control with adjustable start point and operating range, operation of frost protection monitors QAF21.. and QAF61..
- Positioning force 2800 N
- Actuator versions with or without spring-return function
- For direct mounting on valves; no adjustments required
- Manual adjuster and position indicator
- Optional functions with auxiliary switches, potentiometer, stem heater and mechanical stroke inverter
- **SKB..U** are UL-approved

Use

For the operation of Siemens 2-port and 3-port valves, types VVF..., VVG..., VXF... and VXG... with a 20 mm stroke as control and safety shut-off valves in heating, ventilation and air conditioning systems.

Types

	Type	Operating voltage	Positioning signal	Spring-return		Positioning time		Enhanced functions
				Function	Time	Opening	Closing	
Standard electronics	SKB32.50	AC 230 V	3-position			120 s	120 s	
	SKB32.51			yes	10 s			
	SKB82.50	AC 24 V				120 s	10 s	
	SKB82.50U *							
	SKB82.51			yes	10 s			
	SKB82.51U *							
Enhanced electronics	SKB62	DC 0...10 V, 4...20 mA, or 0...1000 Ω	yes	10 s	120 s	10 s		
	SKB62U *							
	SKB60							
	SKB62UA *		yes	10 s	yes ¹⁾			

¹⁾ Direction of operation, stroke limit control, sequence control, signal addition

* UL-approved versions

Accessories

Type	Description	For actuator	Mounting location
ASC1.6	Auxiliary switch	SKB6..	1 x ASC 1.6
ASC9.3	Dual auxiliary switches	SKB32.. SKB82..	1 x ASC9.3 or
ASZ7.3	Potentiometer 1000 Ω		1 x ASZ7.3 or
ASZ7.31	Potentiometer 135 Ω		1 x ASZ7.31 or
ASZ7.32	Potentiometer 200 Ω		1 x ASZ7.32
ASZ6.5	Stem heater AC 24 V	SKB..	1 x ASZ6.5
ASK51	Mechanical stroke inverter		1 x ASK51

Ordering

When ordering please specify the quantity, product name and type code.

Example: **1 actuator, type SKB32.50** and

1 potentiometer, 135 Ω, type ASZ7.31



Delivery

The actuator, valve and accessories are supplied in separate packaging and not assembled prior to delivery.

Spare parts

See overview, section «Replacement parts», page 15.

Equipment combinations

Valve type	DN	PN-class	k_{vs} [m ³ /h]	data sheet
 Two-port valves VV... (control valves or safety shut-off valves):				
VVF21.. Flange	25...80	6	1,9...100	4310
VVF31.. Flange	15...80	10	2,5...100	4320
VVF40.. Flange	15...80	16	1,9...100	4330
VVF41.. Flange	50	16	19...31	4340
VVF45.. Flange	50	16	19...31	4345
VVG41.. Threaded	15...50	16	0,63...40	4363
VVF52.. Flange	15...40	25	0,16...25	4373
VVF61.. Flange	15...50	40	0,19...31	4382
 Three-port valves VX... (control valves for «mixing» and «distribution»):				
VXF21.. Flange	25...80	6	1,9...100	4410
VXF31.. Flange	15...80	10	2,5...100	4420
VXF40.. Flange	15...80	16	1,9...100	4430
VXF41.. Flange	15...50	16	1,9...31	4440
VXG41.. Threaded	15...50	16	1,6...40	4463
VXF61.. Flange	15...50	40	1,9...31	4482

For admissible differential pressures Δp_{max} and closing pressures Δp_s , refer to the relevant valve data sheets.

Note Third-party valves with strokes between 6...20 mm can be motorized, provided they are «closed with the de-energized» fail-safe mechanism and provided that the necessary mechanical coupling is available. For SKB32.. and SKB82.. the Y1 signal must be routed via an additional freely-adjustable end switch (ASC9.3) to limit the stroke.

We recommend that you contact your local Siemens office for the necessary information.

Technology

Principle of electro-hydraulic actuators

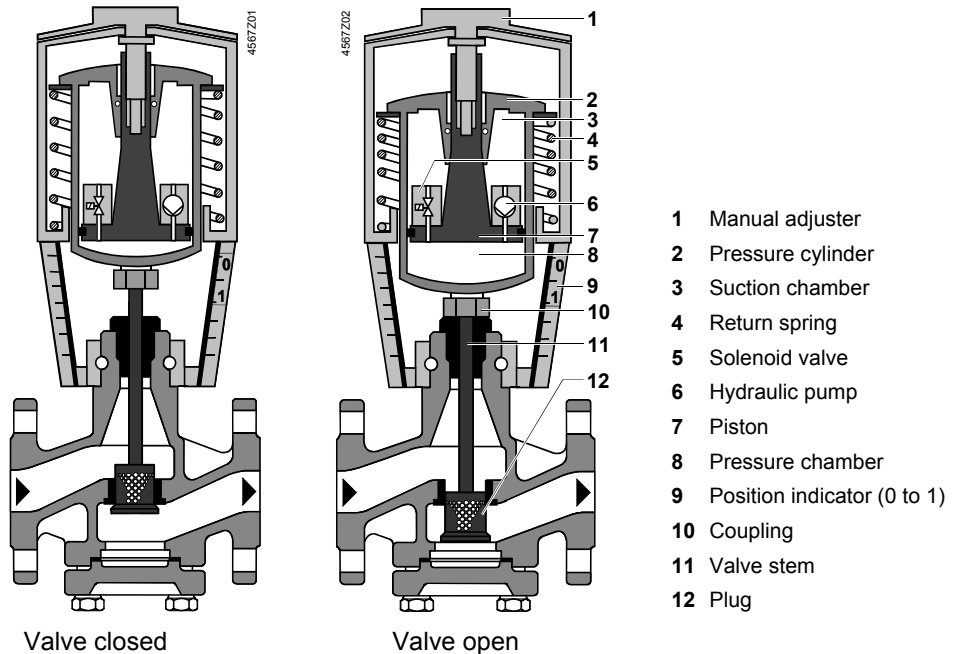

Opening the valve	The hydraulic pump (6) forces oil from the suction chamber (3) to the pressure chamber (8) and thereby moving the pressure cylinder (2) downwards. The valve stem (11) retracts and the valve opens. Simultaneously the return spring (4) is compressed.
Closing the valve	Activating the solenoid valve (5) allows the oil in the pressure chamber to flow back into the suction chamber. The compressed return spring moves the pressure cylinder upwards. The valve stem extends and the valve closes
Manual operation mode	Turning the manual adjuster (1) clockwise moves the pressure cylinder downwards and opens the valve. Simultaneously the return spring is compressed. In the manual operation mode the control signals Y and Z can further open the valve but cannot move to the «0%» stroke position of the valve. To retain the manually set position, switch off the power supply or disconnect the control signals Y and Z. The red indicator marked «MAN» is visible.
Note: Controller in manual operation	When setting the controller for a longer time period to manual operation, we recommend adjusting the actuator with the manual adjuster to the desired position. This guarantees that the actuator remains in this position for that time period. Attention: Do not forget to switch back to automatic operation after the controller is set back to automatic control.
Automatic mode	Turn the manual adjuster counterclockwise to the end stop. The pressure cylinder moves upward to the «0%» stroke position of the valve. The red indicator marked «MAN» is no longer visible.
Minimal volumetric flow	The actuator can manually be adjusted to a stroke position > 0 % allowing its use in applications requiring constantly a minimal volumetric flow.

Spring-return facility

The SKB32.51, SKB82.51.. and SKB62.. actuators, which feature a spring-return function, incorporate an additional solenoid valve which opens if the control signal or power fails. The return spring causes the actuator to move to the «0 %» stroke position and closes the valve in accordance with the safety requirements set out in DIN 32730.

SKB32../SKB82..
3-position control signal

The valve is controlled by a 3-position signal either via terminals Y1 or Y2 and generates the desired stroke by means of above described principle of operation.

- Voltage on Y1 piston extends valve opens
- Voltage on Y2 piston retracts valve closes
- No voltage on Y1 and Y2 piston / valve stem remain in the respective position

SKB62.., SKB60
Y control signal
DC 0...10 V and/or
DC 4...20 mA,
0...1000 Ω

The valve is either controlled via terminal Y or override control Z. The positioning signal Y generates the desired stroke by means of above described principle of operation.

- Signal Y increasing: piston extends valve opens
- Signal Y decreasing: piston retracts valve closes
- Signal Y constant: piston / valve stem remain in the respective position
- Override control Z see description of override control input, page 7

Frost protection monitor
Frost protection
thermostat

A frost protection thermostat can be connected to the SKB6.. actuator. The added signals from the QAF21.. and QAF61.. require the use of SKB62UA actuators. Notes on special programming of the electronics are described under «Enhanced electronics» on page 5.



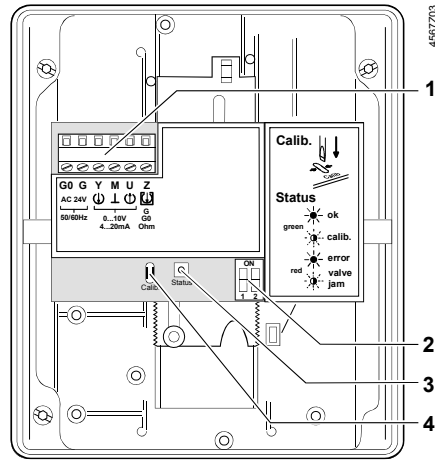

«Connection diagrams» for operation with frost protection thermostat or frost protection monitor refer to page 14.

Standard electronics
SKB62.., SKB60



- 1 Connection terminals
- 2 Mode DIL switches
- 3 LED status indication
- 4 Slot for calibration

DIL switches
SKB62.., SKB60

	Positioning signal Y Position feedback U	Flow characteristic
ON	 DC 4...20 mA	 lin = linear
OFF *)	 DC 0...10 V	 log = equal percentage

*) Factory setting:
All switches OFF

Relationship
between control
signal Y and
volumetric flow

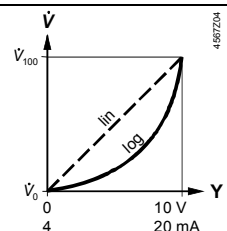

Enhanced electronics
SKB62UA

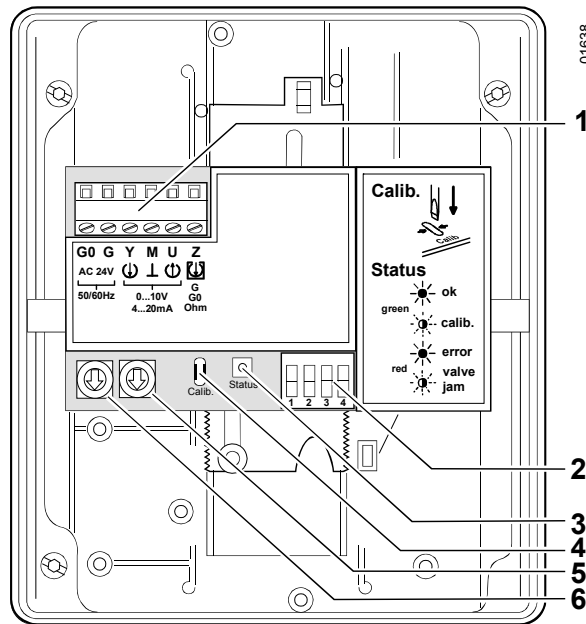

DIL switches
SKB62UA

	Direction of operation	Sequence control or stroke limit control	Control signal Y Position feedback U	Flow characteristic
ON	reverse-acting	Sequence control Signal addition QAF21../QAF61..	DC 4... 20 mA	lin = linear
OFF *	direct-acting	Stroke limit control	DC 0...10 V	log = equal percentage

* Factory settings: all switches OFF

Relationship between control signal Y and volumetric flow

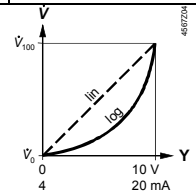

Selection of direction of operation
SKB62UA

- With normally-closed valves, «direct-acting» means that with a signal input of 0 V, the valve closes (applies to all Siemens valves listed under «Equipment combinations» on page 2)
- With normally-open valves, «direct-acting» means that with a signal input of 0 V, the valve is open.

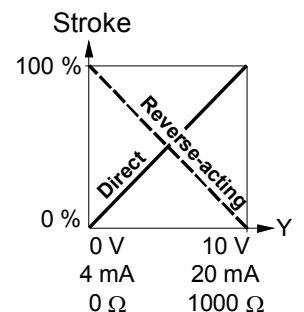
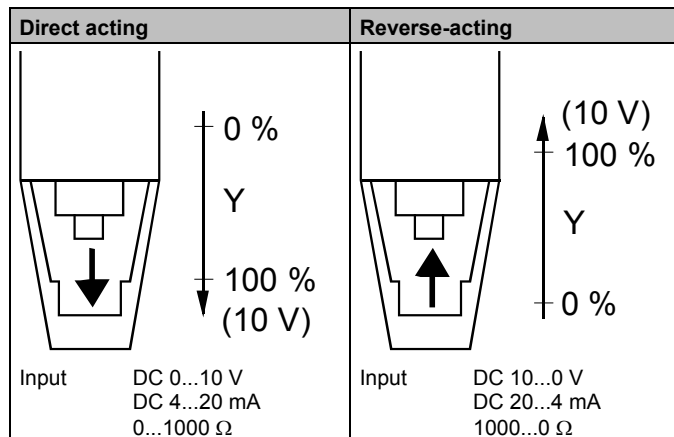

Note The mechanical spring-return function is not affected by the direction of operation selected.

Stroke limit control
and sequence control
SKB62UA

Setting the stroke limit control

The rotary switches LO and UP can be used to apply an upper and lower limit to the stroke in increments of 3%, up to a maximum of 45%

Position of LO	Lower stroke limit	Position of UP	Upper stroke limit
0	0 %	0	100 %
1	3 %	1	97 %
2	6 %	2	94 %
3	9 %	3	91 %
4	12 %	4	88 %
5	15 %	5	85 %
6	18 %	6	82 %
7	21 %	7	79 %
8	24 %	8	76 %
9	27 %	9	73 %
A	30 %	A	70 %
B	33 %	B	67 %
C	36 %	C	64 %
D	39 %	D	61 %
E	42 %	E	58 %
F	45 %	F	55 %

Setting the sequence control

The rotary switches LO and UP can be used to determine the starting point or the operating range of a sequence.

Position of LO	Starting point for sequence control	Position of UP	Operating range of sequence control
0	0 V	0	10 V
1	1 V	1	10 V *
2	2 V	2	10 V **
3	3 V	3	3 V ***
4	4 V	4	4 V
5	5 V	5	5 V
6	6 V	6	6 V
7	7 V	7	7 V
8	8 V	8	8 V
9	9 V	9	9 V
A	10 V	A	10 V
B	11 V	B	11 V
C	12 V	C	12 V
D	13 V	D	13 V
E	14 V	E	14 V
F	15 V	F	15 V

* Operating range of QAF21.. (see below)
 ** Operating range of QAF61.. (see below)
 *** The smallest adjustment is 3 V; control with 0...30 V is only possible via Y.

Stroke control with
QAF21.. / QAF61..
signal addition
SKB62UA only

Setting the signal addition

The operating range of the frost protection monitor (QAF21.. or QAF61..) can be defined with rotary switches LO and UP.

Position of LO	Sequence control start point	Position of UP	QAF21.. / QAF61.. operating range
0		1	QAF21..
0		2	QAF61..

Calibration
SKB62.., SKB60

In order to determine the stroke positions 0 % and 100 % in the valve, calibration is required on initial commissioning:

Prerequisites

- Mechanical coupling of the actuator SKB6.. with a Siemens valve
- **⚠ Actuator must be in «Automatic operation» enabling stroke calibration to capture the effective 0 % and 100 % values**
- AC 24 V power supply
- Housing cover removed

Calibration

1. Short-circuit contacts in calibration slot (e.g. with a screwdriver)
2. Actuator moves to «0 %» stroke position (1) (valve closed)
3. Actuator moves to «100 %» stroke position (2) (valve open)
4. Measured values are stored

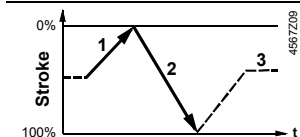
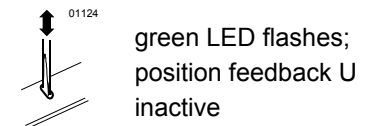

Normal operation





5. Actuator moves to the position (3) as indicated by signals Y or Z

green LED is lit permanently;
position feedback U active, the values correspond to the actual positions

A lit red LED indicates a calibration error.
The calibration can be repeated any number of times.

Indication of operating state
SKB62..., SKB60



The LED status indication indicates operational status with dual-colored LED and is visible with removed cover.

LED	Indication	Function	Remarks, troubleshooting
Green	Lit 	Normal operation	Automatic operation; everything o.k.
	Flashing 	Calibration in progress	Wait until calibration is finished (LED stops flashing, green or red LED will be lit)
Red	Lit 	Faulty stroke calibration Internal error	Check mounting Restart stroke calibration (by short-circuiting calibration slot) Replace electronics
	Flashing 	Inner valve jammed	Check valve
Both	Dark 	No power supply Electronics faulty	Check mains network, check wiring Replace electronics

As a general rule, the LED can assume only the states shown above (continuously red or green, flashing red or green, or off).

Override control input Z
SKB62..., SKB60

Override control input can be operated in following different modes of operation

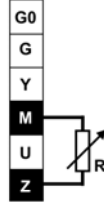
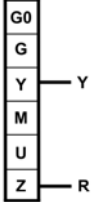
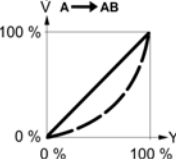
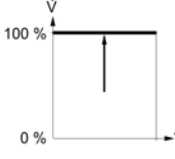
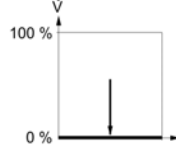
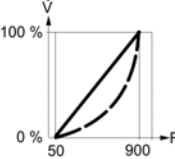
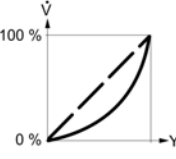
		Z-mode				
		no function	fully open	closed	override with 0...1000 Ω	Signal addition SKB62UA only
Connections						
						
		linear or equal-percentage			linear or equal-percentage	linear or equal-percentage
		<ul style="list-style-type: none"> Z-contact not connected Valve stroke follows Y-input 	<ul style="list-style-type: none"> Z-contact connected directly to G Y-input has no effect 	<ul style="list-style-type: none"> Z-contact connected directly to G0 Y-input has no effect 	<ul style="list-style-type: none"> Z-contact connected to M via resistor R Starting position at 50 Ω / end position at 900 Ω Y-input has no effect 	<ul style="list-style-type: none"> Z-contact is connected to R of the frost protection monitor QAF21.. or QAF61.. Valve stroke follows signals Y and R(Z)

Note Shown operation modes are based on the factory setting «direct acting»
Y-input has no effect in Z-mode.

Accessories

SKB..

ASZ6.5
stem heater

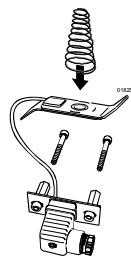

- for media below 0 °C
- mount between valve and actuator

SKB32..., SKB82..

ASC9.3
double auxiliary switch

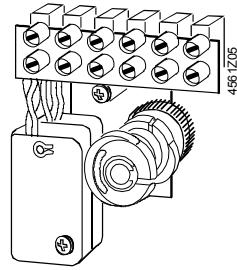

adjustable switching points

ASZ7.3..
potentiometer

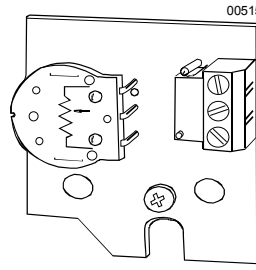

ASZ7.3: 0...1000 Ω
ASZ7.31: 0...135 Ω
ASZ7.32: 0...200 Ω

ASK51
stroke inverter

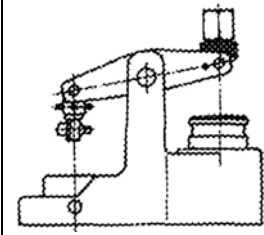

0 % actuator stroke corresponds to 100 % valve stroke; mount between valve and actuator

SKB62..., SKB60

ASC1.6
auxiliary switch

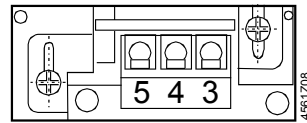

switching point 0...5 % stroke

See section «Technical data» on page 11 for more information.

Engineering notes

Conduct the electrical connections in accordance with local regulations on electrical installations as well as the internal or connection diagrams.

Caution 

Safety regulations and restrictions designed to ensure the safety of people and property must be observed at all times!

Caution 

For media below 0 °C the ASZ6.5 stem heater is required to keep the valve from freezing. For safety reasons the stem heater is designed for an operating voltage of AC 24 V / 30 W.

For this case, do not insulate the actuator bracket and the valve stem, as air circulation must be ensured. Do not touch the hot parts without prior protective measures to avoid burns.

Non-observance of the above may result in accidents and fires!

Recommendation: Above 140 °C insulating the valves is strictly recommended.

Observe admissible temperatures, refer to «Use» on page 1 and «Technical data» on page 11

If an auxiliary switch is required, its switching point should be indicated on the plant schematic.

Every actuator must be driven by a dedicated controller, refer to «Connection diagrams», page 14.

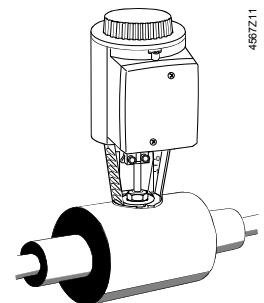

Mounting instructions

Mounting Instruction 74 319 0324 0 for fitting the actuator to the valve are by packed in the actuator packaging. The instructions for accessories are enclosed with the accessories themselves.

Accessories	Installation instructions		Accessory	Mounting instructions	
ASC1.6	G4563.3	4 319 5544 0	ASZ6.5	M4563.7	4 319 5564 0
ASC9.3	G4561.3	4 319 5545 0	ASK51	M4561.6	4 319 5550 0
SKB..	M3240	74 319 0324 0	ASZ7.3..		74 319 0247 0
SKB..		74 319 0326 0	ACT control unit	M4568	74 319 0554 0
			QAF21..		74 319 0399

Orientation

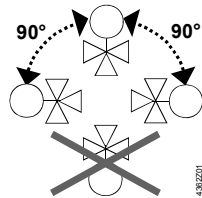

Commissioning notes

When commissioning the system, check the wiring and functions, and set any auxiliary switches and potentiometers as necessary, or check the existing settings.

Cylinder with valve stem connector fully retracted
→ stroke = 0%

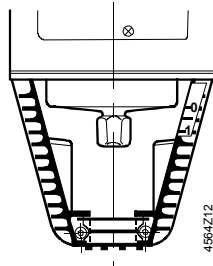

Cylinder with valve stem connector fully extended
→ stroke = 100 %

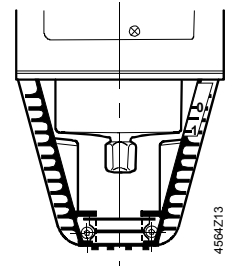

The manual adjuster must be rotated counterclockwise to the end stop. This causes the Siemens valves, types VVF.. and VXF.. to close (stroke = 0 %).

Automatic operation

For automatic operation, the crank (2) on the manual adjustment knob (1) must be engaged. If not engaged, turn the crank counter-clockwise until the display window (3) neither shows the scale (4) nor the crank engagement bar.

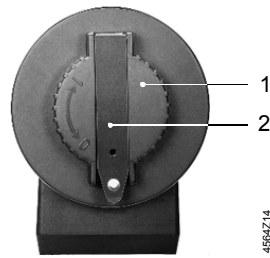

Engaged crank (2) on the manual adjustment knob (1)

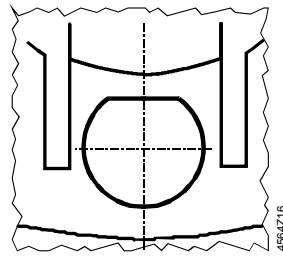

Display window with invisible scale dial and crank engagement bar

Manual operation

For manual operation, swing out the crank (2) so that the display window (3) becomes visible. By rotating the crank or the manual adjustment knob (1), the display window shows the engagement bar and/or the scale dial with stroke indication.

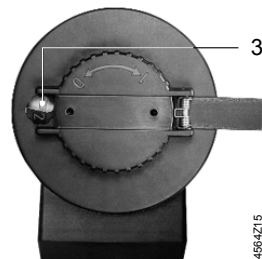

Swung-out crank, display window (3)

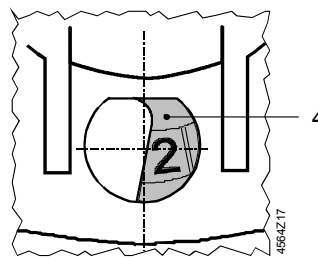

Display window with scale dial (4) and stroke indication

Maintenance notes

The SKB.. actuators are maintenance-free.



When servicing the actuator:

- Switch off pump of the hydronic loop
- Interrupt the power supply to the actuator
- Close the main shutoff valves in the system
- Release pressure in the pipes and allow them to cool down completely
- If necessary, disconnect electrical connections from the terminals
- The actuator must be correctly fitted to the valve before recommissioning.

Repair

Recommendation SKB6...: trigger stroke calibration.

«Replacement parts», see page 15.

Disposal



The device contains electrical and electronic components and must not be disposed of together with domestic waste. This applies in particular to the PCB.

Legislation may demand special handling of certain components, or it may be sensible from an ecological point of view.

Current local legislation must be observed.

Warranty



The technical data relating to specific applications are valid only in conjunction with the valves listed in this Data Sheet under «Equipment combinations», page 2.

The use of the actuators in conjunction with third-party valves invalidates all claims under Siemens Switzerland Ltd / HVAC Products warranty.

Technical data

		SKB32..	SKB82..	SKB6..
Power supply	Operating voltage	AC 230 V	AC 24 V	AC 24 V
	Voltage tolerance	± 15 %	± 20 %	-20 % / +30 %
		SELV / PELV		
	Frequency	50 or 60 Hz		
	Max. Power consumption at 50 Hz	SKB32.50: 10 VA / 8 W SKB32.51: 15 VA / 13 W	SKB82.50, ..50U 13 VA / 8 W SKB82.51, ..51U 18 VA, 11 W	SKB62.. 17 VA / 12 W SKB60.. 13 VA / 10 W
External supply cable fuse	min. 0.5 A, slow max. 6 A, slow	min. 1 A, slow max. 10 A, slow		
Signal inputs	Control signal	3-position		DC 0...10 V, DC 4...20 mA or 0...1000 Ω
	Terminal Y	Voltage Input impedance Current Input impedance Signal resolution Hysteresis		DC 0...10 V 100 kΩ DC 4...20 mA 240 Ω < 1% 1 %
	Terminal Z Override control	Resistor Z not connected Z connected directly to G Z connected directly to G0 Z connected to M via 0...1000 Ω		0...1000 Ω No function, priority terminal Y max. stroke 100 % min. stroke 0 % stroke proportional to R
	Terminal U	voltage load impedance Current load impedance		DC 0...9,8 V ±2 % > 10 kΩ DC 4...19,6 mA ±2 % < 500 Ω
Position feedback	Positioning time at 50 Hz			
	opening	SKB32.5.. 120 s	SKB82.5.. 120 s	120 s
	Closing	SKB32.5.. 120 s	SKB82.5.. 120 s	10 s
	Spring-return time (closing)	SKB32.51 10 s SKB32.50 -	SKB82.51 10 s SKB82.50 -	SKB60, SKB62 - SKB62.. 10 s
	Positioning force	2800 N		
Nominal stroke	20 mm			
Max. permissible medium temperature	-25...220 (350) °C < 0 °C: requires stem heater ASZ6.5			
Electrical connections	Cable entry	4 x M20 (Ø 20,5 mm) ..U with knockouts for standard ½" conduit connectors (Ø 21.5 mm)		
Norms and standards	CE-conformity	2004/108/EC		
	EMC-directive	Immunity EN 61000-6-2 Industrial Emission EN 61000-6-3 Residential		
	Low voltage directive	2006/95/EC		
	Electrical safety	EN 60730-1		
	Product standards for automatic electric controls	EN 60730-2-14		
	Protection standard EN 60730	I	III	
	Housing protection standard Upright to horizontal	IP54 to EN 60529		

	SKB32..	SKB82..	SKB6..
Conform with UL standards	SKB82..U SKB62U, SKB62UA	UL 873	UL873
C-tick		N474	N474
Environmental compatibility	ISO 14001 (Environment) ISO 9001 (Quality) SN 36350 (Environmentally compatible products) RL 2002/95/EG (RoHS)		
Dimensions / Weight	Dimensions refer to «Dimensions», page 15		
Weight (incl. packaging)	SKB32.50.. 8.50 kg SKB32.51.. 8.90 kg	SKB82.50.. 8.50 kg SKB82.51.. 8.90 kg	8,60 kg
Materials	ASK51 stroke inverter	1.10 kg	
	Actuator housing, bracket	Die-cast aluminum	
	Housing box and manual adjuster	Plastic	

Accessories		SKB32.., SKB82..	SKB6..
ASC1.6 Auxiliary switch	Switching capacity		AC 24 V, 10 mA...4 A resistive, 2 A inductive
ASC9.3 double auxiliary switch	Switching capacity per auxiliary switch	AC 250 V, 6 A resistive, 2.5 A inductive	
ASZ7.3 Potentiometer	Change in overall resistance of potentiometer at nominal stroke	ASZ7.3 0...1000 Ω ASZ7.31 0...135 Ω ASZ7.32 0...200 Ω	
ASZ6.5 stem heater	Operating voltage	AC 24 V ± 20 %	
	Power consumption	30 VA	

SKB62UA enhanced functions

Direction of operation	Direct-acting, reverse-acting	DC 0...10 V / DC 10...0 V DC 4...20 mA / DC 20...4 mA 0...1000 Ω / 1000...0 Ω
Stroke limit control	Range of lower limit Range of upper limit	0...45 % adjustable 100...55 % adjustable
Sequence control	Terminal Y Starting point of sequence Operating range of sequence	0...15 V adjustable 3...15 V adjustable
Signal addition	Z connected to R of Frost protection monitor QAF21.. Frost protection monitor QAF61..	0...1000 Ω, added to Y signal DC 1.6 V, added to Y signal

General ambient conditions	Operation	Transport	Storage
	EN 60721-3-3	EN 60721-3-2	EN 60721-3-1
Environmental conditions	Class 3K5	Class 2K3	Class 1K3
Temperature	-15...55 °C	-30...65 °C	-15...55 °C
Humidity	5...95 % rh	< 95 % rh	5...95 % rh

Internal diagrams

SKB32.51

AC 230 V, 3-Position

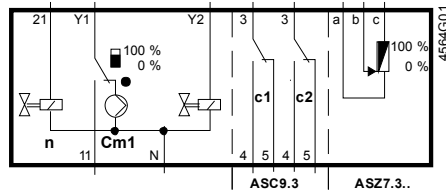

- Cm1** end switch
- n** solenoid valve for spring-return
- c1, c2** ASC9.3 double auxiliary switch
- a, b, c** ASZ7.. potentiometer
- Y1** Positioning signal «open»
- Y2** Positioning signal «close»
- 21** spring-return function
- N** neutral conductor

SKB32.50

AC 230 V, 3-Position

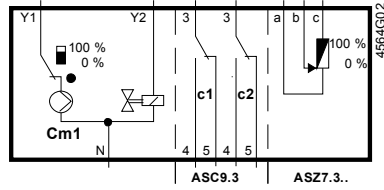

SKB82.51

AC 24 V, 3-Position

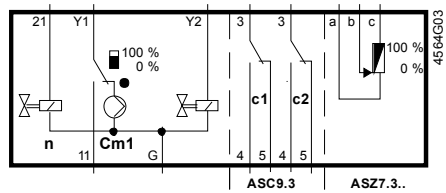

- Cm1** end switch
- n** solenoid valve for spring-return
- c1, c2** ASC9.3 double auxiliary switch
- a, b, c** ASZ7.. potentiometer
- Y1** Positioning signal «open»
- Y2** Positioning signal «close»
- 21** spring-return function
- G** System potential

SKB82.50

AC 24 V, 3-Position

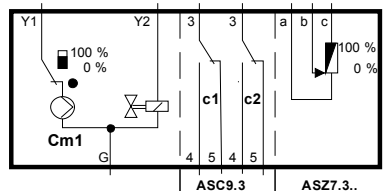

SKB60, SKB62

SKB60U, SKB62U

SKB62UA

AC 24 V, DC 0...10 V,
4...20 mA, 0...1000 Ω

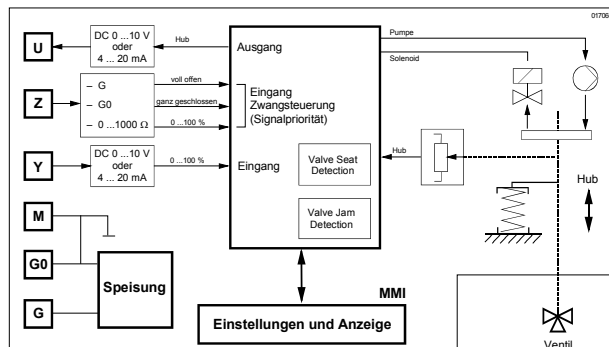

- U** position indication
- Z** override control
- Y** positioning signal
- M** measuring neutral
- G0** operating voltage AC 24 V: system neutral (SN)
- G** operating voltage AC 24 V: system potential (SP)

Connection terminals

SKB6..

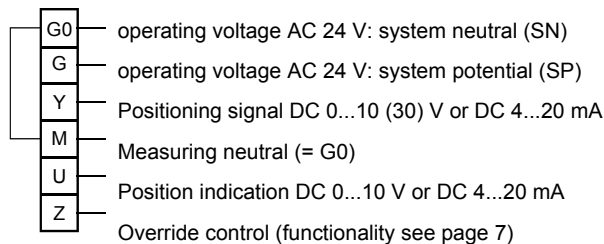

Auxiliary switch

ASC1.6

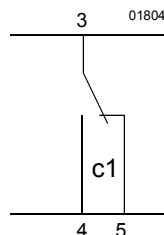

Connection diagrams

SKB32..
AC 230 V
3-Position

SKB32.51

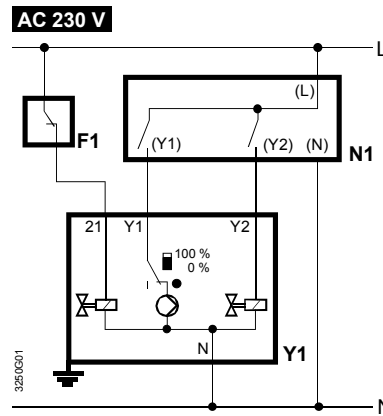

F1 temperature limiter
N1, N2 controller
Y1, Y2 actuators
L Phase
N neutral

SKB32.50

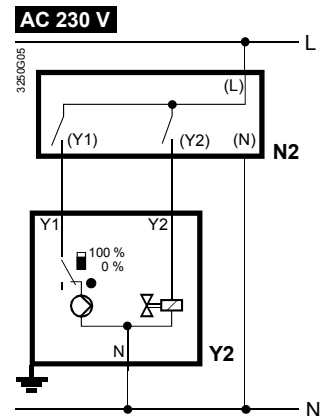

Y1 Positioning signal «open»
Y2 Positioning signal «close»
21 Spring-return function

SKB82..
AC 24 V
3-Position

SKB82.51, SKB82.51U

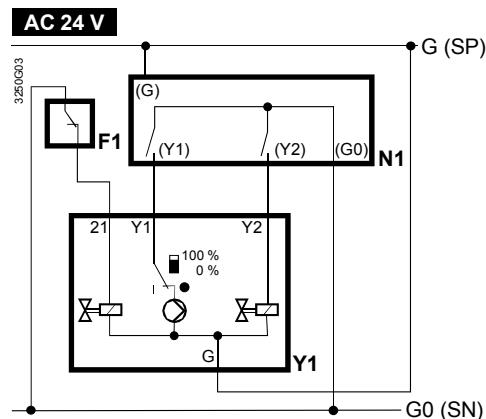

F1 temperature limiter
N1, N2 controller
Y1, Y2 actuators
SP Systempotential AC 24 V
SN System neutral

SKB82.50, SKB82.50U

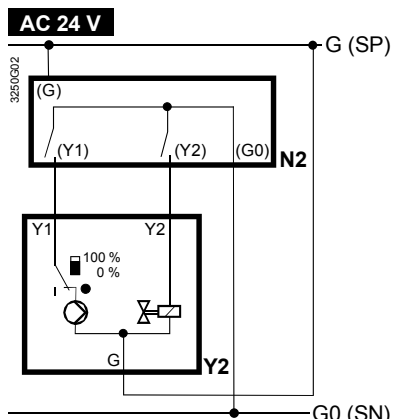

Y1 Positioning signal «open»
Y2 Positioning signal «close»
21 Spring-return function

SKB6..
AC 24 V
DC 0...10 V, 4...20 mA,
0...1000 Ω

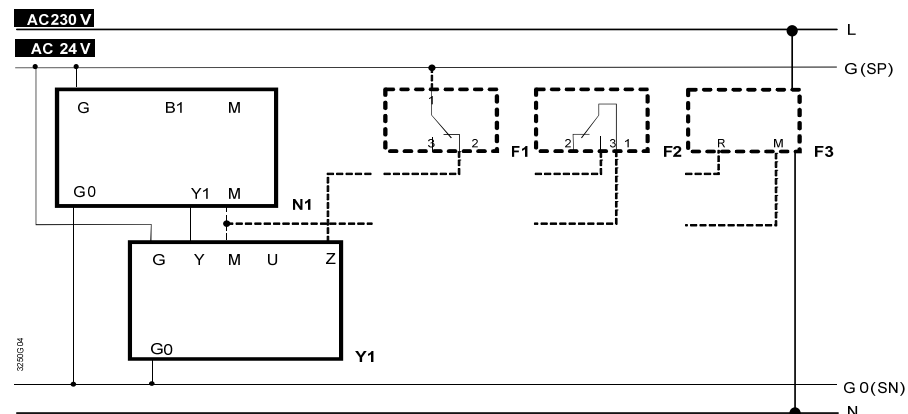

Y1 actuator
N1 controller
F1 temperature limiter
F2 frost protection thermostat
terminals: 1 – 3 frost hazard / sensor is interrupted
(thermostat closes with frost)
1 – 2 normal operation
F3 frost protection monitor QAF21.. or QAF61.. (for SKB62UA only) *
G (SP) System potential AC 24 V
G0 (SN) System neutral

* Only with sequence control and the appropriate selector switch settings (see page 6)

Dimensions

All dimensions in mm

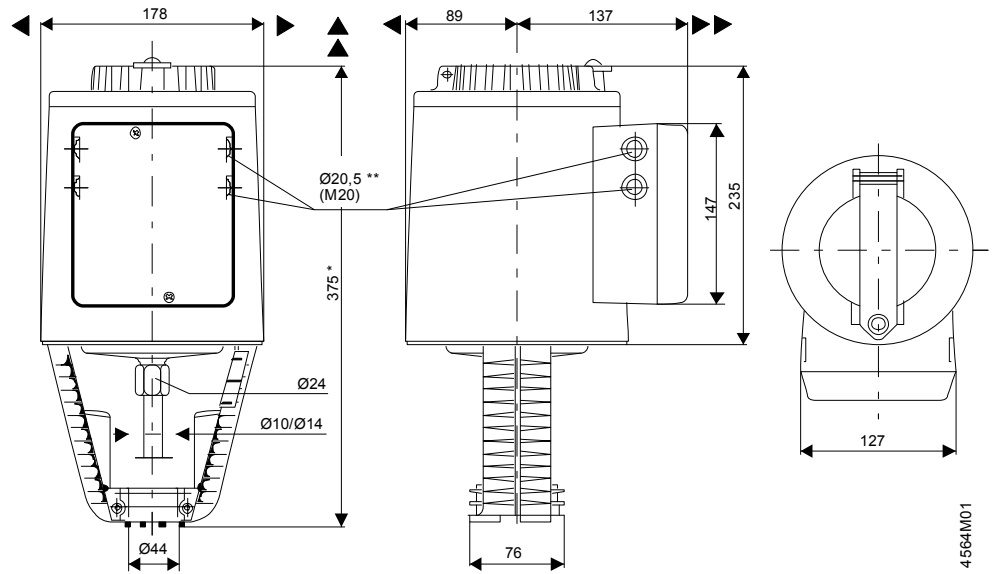

4564M01

* Height of actuator from plate with stroke inverter **ASK51** = 432 mm

** **SKB..U:** with knockouts for standard ½" conduit connectors (Ø 21.5 mm)

▶ = > 100 mm | Minimum clearance from ceiling or wall for mounting,

▶▶ = > 200 mm | connection, operation, maintenance etc.



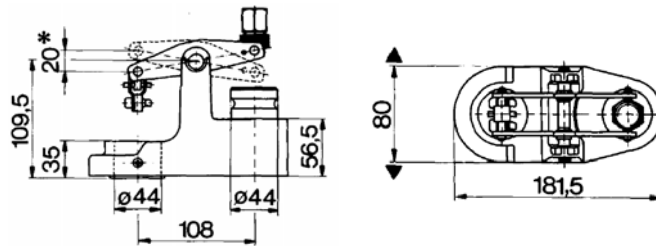

ASK51 stroke inverter



* Maximum stroke = 20 mm

Replacement parts

Order numbers for replacement parts

	Cover	Hand control ¹⁾	Clamp	Stem connection	Control unit
Actuator type					
SKB32.50	410455828	426855108	410355768	417856498	
SKB32.51	410455828	426855108	410355768	417856498	
SKB82.50	410455828	426855108	410355768	417856498	
SKB82.50U	410455828	426855108	410356058	417856498	
SKB82.51	410455828	426855108	410355768	417856498	
SKB82.51U	410455828	426855108	410356058	417856498	
SKB62	410455828	426855108	410355768	417856498	466857488
SKB62U	410455828	426855108	410356058	417856498	466857488
SKB60	410455828	426855108	410355768	417856498	466857598
SKB62UA	410455828	426855108	410356058	417856498	466857518

1) hand control, blue with mechanical parts

