

Synco™900



## Heating Circuit Controller

## RRV918

- RF-controlled heating circuit controller for up to 8 heating circuits
- RF communication based on KNX standard (868 MHz, bidirectional)
- Connection facility for up to eight 2-position actuators
- Mains-powered AC 230 V
- 1 universal relay output
- 1 universal input

### Use

- For integration into the Siemens Synco 900 system
- Suited for use in heating plant
  - With central heat distributors (e.g. underfloor heating or soft steel piping system)
  - For use with motorized radiator valves (e.g. with sill covers)
- Heating circuit control with 2-position actuators
- Universal relay output, e.g. for control of the apartment pump, DHW heating, or fan speeds
- Universal input, e.g. for connection of a DHW temperature sensor or an alarm

**Equipment combinations**

The RRV918 heating circuit controller is designed for use with the Siemens Synco 900 system. For more detailed information about equipment combinations, refer to the Data Sheet covering the central apartment unit (CE1N2707en).

The RRV918 can be used in connection with the following types of actuators from Siemens, depending on the application:

**Heat distributor with individual room control**

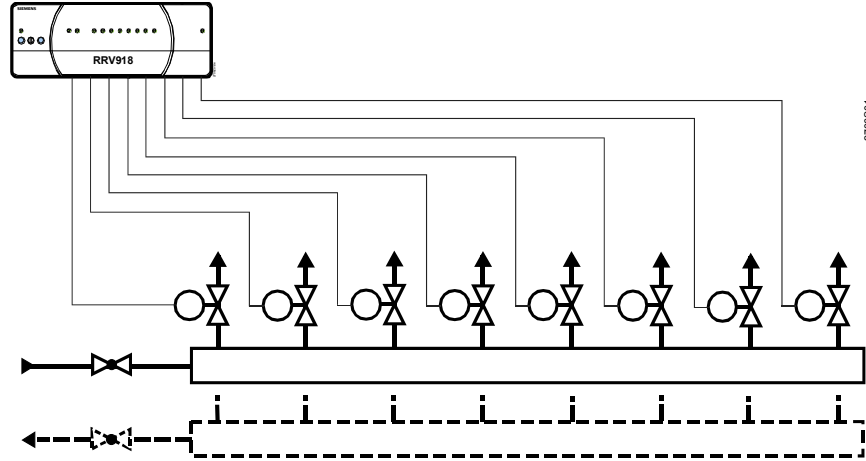

<b>Type of actuator</b>	<b>STA21</b>	<b>STP21</b>
	Thermal	Thermal
<b>Data Sheet no.</b>	N4877	N4878
<b>Normal state</b>	NC	NO
<b>Type of valve</b>	Depending on the type of heat distributor, connection M30 x 1.5 mm	

**Radiators**

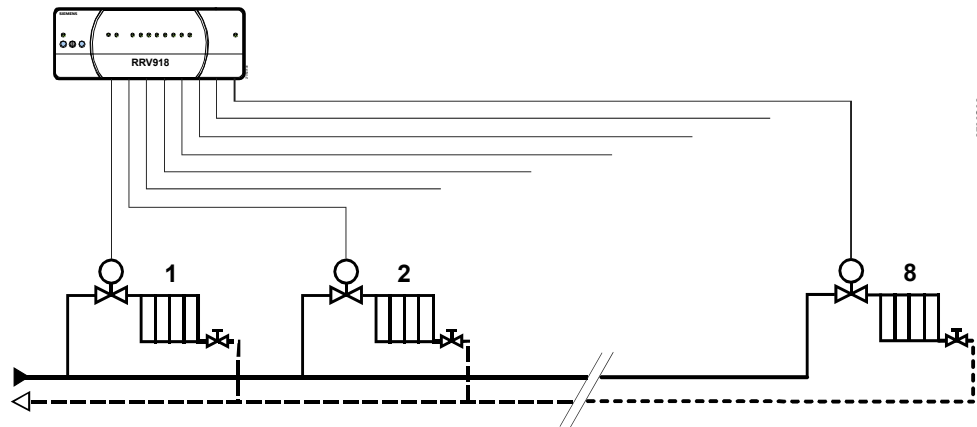

<b>Type of actuator</b>	<b>STA21</b>	<b>STP21</b>
	Thermal	Thermal
<b>Data Sheet no.</b>	N4877	N4878
<b>Normal state</b>	NC	NO
<b>Type of valve</b>	VDN..., VEN..., VUN..., VPD..., VPE...	

Also refer to Data Sheet CE1N2100en: Small valves, actuators and accessories.

## Ordering

---

When ordering, please give quantity, product name and type reference.

## Scope of delivery

The RRV918 is supplied complete with Mounting Instructions.

## Product documentation

---

The Operating and Commissioning Instructions for the RRV918 are contained in the product documentation of the central apartment unit.

## Functions

---

### Main function

In operation, the RRV918 maintains the required room temperature of the individual heating circuits. The central apartment unit delivers the relevant data via RF.

### Universal relay output

The universal relay output can be used to control different types of devices. Release is controlled via the central apartment unit and delivered via RF.<sup>1</sup>

### Universal input

The universal input is used for connection of the DHW temperature sensor, for example. The data are forwarded to the central apartment unit via RF.<sup>1</sup>

### Parallel operation

Several heating circuits can be assigned to one room and, therefore, operated in parallel. In that case, the first heating circuit ensures the actual room control and, at the same time, controls the other assigned heating circuits.

### Antilime function

The antilime function is triggered by the central apartment unit. When receiving an antilime command, the heating circuit valve will be fully opened and then closed again. When the antilime function is completed, the valve will return to the previous control position.

### Summer operation

Summer operation is triggered by the central apartment unit. When receiving a command to start summer operation, the heating circuit valve will be opened or closed, depending on the position predefined by the central apartment unit. If the antilime function is activated in summer operation, it will be performed. When completed, the control loops will resume summer operation.

### Window airing

The window airing function is triggered by the central apartment unit. The function interferes in the control process in a way that overheating of the room will be avoided both during and after the window airing time.

### Frost protection for the room

Frost protection for the room becomes active if the room temperature drops below the frost protection setpoint. It remains active until the room temperature returns to a level 1 K above the frost protection setpoint.

### Binding

The binding of the first selected channel is used by the RRV918 to sign on at the central apartment unit, thus ensuring integration into the RF system. Then, the other channels can be assigned to other rooms or function groups. The binding process is triggered via the multifunction button and indicated by the multifunction LED.

---

<sup>1</sup> For detailed information about assignment options for the inputs and outputs, refer to the Synco 900 Mounting and Commissioning Instructions (CE1C2707en).

- Status query** The multifunction button can be used to query the state of the configured control channels. The state is indicated by the multifunction LED.
- RF binding test** The multifunction button can be used to trigger a binding test per channel. The test is made to check the radio link to the central apartment unit. The RF binding test is indicated by the multifunction LED.
- Resetting a channel** The multifunction button can be used to reset a configured channel to its supply state. Then, the channel must be reconfigured in the system. The state is indicated by the multifunction LED.
- Supply state** The multifunction button can be used to reset the RRV918 to its supply state. Then, the RRV918 must be reintegrated into the system.
- RF failure** If radio transmission between the RRV918 and the central apartment unit breaks down, control is no longer ensured. The heating circuit valves will open. When radio transmission is reestablished, the RRV918 will return to control mode.
- Mains failure** In the event power supply to the RRV918 is interrupted, control is no longer ensured. The positions of the individual actuators can only be changed manually on the actuators themselves. When mains supply is restored, the RRV918 will return to control mode.
- Error messages** The following error messages are delivered by the RRV918:

<b>Error messages</b>
Communication error (no communication for one hour)

## Operating and indicating elements

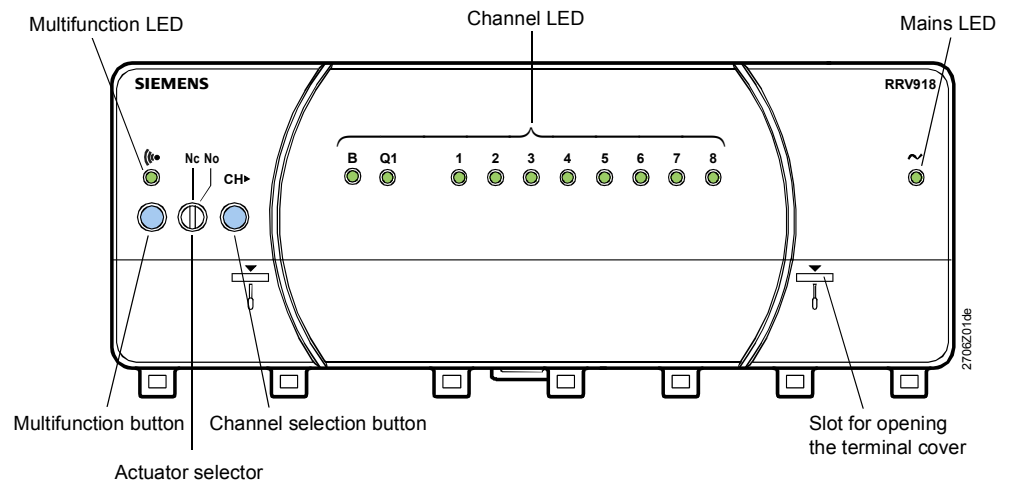

### Function of operating elements

Operating elements	Function
Multifunction button	State query of channel configuration RF binding test Binding Disconnection of channels from the system Restoration of supply state
Actuator selector	Selection of the type of actuator
Channel selection button	Channel selection

### Function of indicating elements

Indicating element	Function
Multifunction LED	Indication of channel configuration RF binding test Binding process Disconnection of channel from the system
Channel LEDs: B Q1 Y1...Y8	Indication of channel configuration / status indication: Universal input Universal relay output Controller outputs
Mains LED	Power supply

For more detailed information about the functions and operation of the RRV918, refer to the product documentation covering the central apartment unit.

## Notes on engineering and operation

---

### Mounting location

- Due to its compact design, the RRV918 can be fitted directly in the heat distribution panel\*, on the ceiling in the cellar, or in the cable riser
- The permissible environmental conditions must be observed
- The RRV918 must not be exposed to dripping water
- For notes relating to engineering and mounting RF devices of the Siemens Synco 900 system, refer to Data Sheet CE1N2708en
- When mounting the RRV918, ensure that there is sufficient space by the connection terminals to introduce the cable ( $\geq 30$  mm)
- At the top of the unit, a minimum clearance of 50 mm must be observed to ensure that the operating elements can be accessed and that the terminal cover can be easily opened.

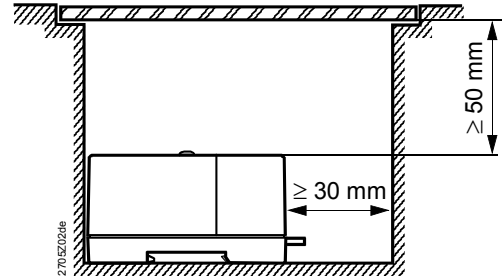

\* Plastic covers are used in place of metal covers to support radio communication.

### Installation

The RRV918 is designed for:

- Mounting on top hat rails conforming to EN 60715-TH35-7,5
- Fitting with the help of 2 fixing screws

Note Prior to applying power, connect all heating circuits and the inputs and outputs.

### Commissioning

Prior to commissioning, check to ensure that the RRV918 is correctly mounted, that all wiring is correctly made, and that power is switched on.

### Maintenance

The RRV918 is maintenance-free.

### Disposal

In terms of disposal regulations, the RRV918 is classified as electronic scrap conforming to the European Directive 2002/96/EG (WEEE) and must not be disposed of as domestic waste. Local and currently valid legislation must be observed.





### Warranty

---

Application-related technical data are only warranted in connection with the Siemens Synco 900 system. For equipment combinations, refer to the Data Sheet of the central apartment unit (CE1N2707en).

**When using the RRV918 together with third-party devices, correct functioning must be ensured by the user. In that case, Siemens will assume no responsibility for service and warranty.**

## Technical data

Power supply	Operating voltage	AC 230V (± 10%)		
	Frequency	50 Hz		
	Power consumption (with no external load)	max. 7 VA		
	Fusing of supply line	10 A		
RF	Frequency	868 MHz (bidirectional)		
	Range	typically 30 m inside buildings		
	Protocol	KNX RF-compatible 		
Universal input	Type	LG-Ni 1000 (on / off)		
	Quantity	1		
	Measuring range	0...120 °C		
Permissible cable length to sensor or external contact	Copper cable 0.6 mm dia.	max. 20 m		
	Copper cable 1 mm <sup>2</sup>	max. 80 m		
	Copper cable 1.5 mm <sup>2</sup>	max. 120 m		
Universal relay output	Type	NO contact AC 24...230 V, AC 0.02...2 (2) A		
	Quantity	1		
Controller output	Type	Triac AC 230 V, max. AC 30 mA		
	Quantity	8		
	Permissible cable length	max. 10 m		
	Screw terminals for	max. 2.5 mm <sup>2</sup>		
Electrical connections				
Type of controller	2-position	PID		
Standards	 conformity to			
	EEC directive	89/336/EC		
	- Immunity	- EN 61000-6-1/2		
	- Emissions	- EN 61000-6-3/4		
	Low-voltage directive	73/23/EC		
	- Electrical safety	- EN 60730-1		
RTTE Radio & Telecom. Equipment	Radio communication		99/5/EEC - EN 300220-1, EN 300220-3, EN 301489-3	
	Safety class	II to EN 60730		
Protection	Housing	IP 30 to EN 60529		
	Degree of pollution	2 to EN 60730		
	Dimensions	refer to "Dimensions"		
Weight	Unit complete with accessories	0.553 kg		
Housing material	plastic PC+ABS			
Housing color	Upper / lower housing section	RAL 7035 light-gray RAL 5014 dove-blue		
Environmental conditions		<b>operation</b>	<b>transport</b>	<b>storage</b>
		EN 60721-3-3	EN 60721-3-2	EN 60721-3-1
	Climatic conditions	class 3K5	class 2K3	class 1K3
	Temperature	0...+50 °C	-25...+70 °C	-20...+65 °C
	Humidity	5...95 % r.h. (noncondens-ing)	<95 % r.h.	5...95 % r.h.
	Mechanical conditions	class 3M2	class 2M2	class 1M2
	Elevation above sea level	min. 700 hPa, corresponding to max. 3,000 m above sea level		

## Connection terminals

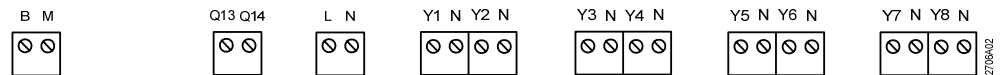

### Legend

L	Operating voltage, live wire AC 230 V
N	Operating voltage, neutral conductor AC 230 V
B	Universal input
M	Ground for universal input
Q13, Q14	Universal relay output (NO) for AC24...230 V
Y1...Y8	Outputs controllers 1...8, AC 230V
N	Neutral conductor for controller output

Note: With controller outputs Y1...Y8, the live wire (L) is switched. The neutral conductor is internally connected. The relay output is potential-free.

## Connection diagram

### 2-position control

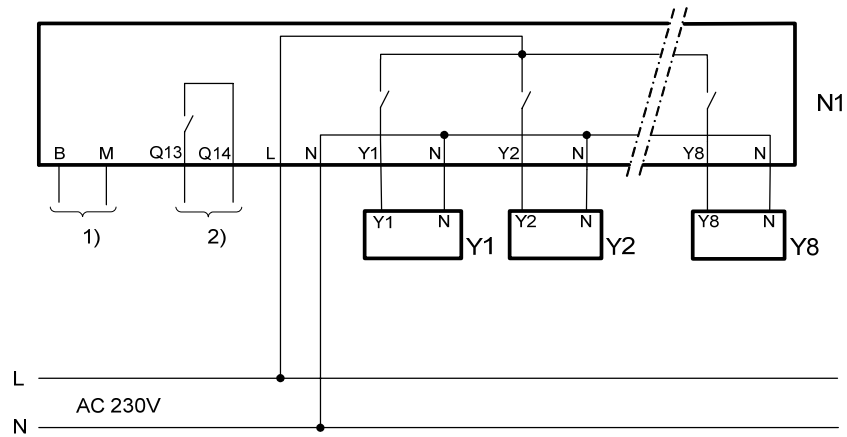

### Legend

N1	Heating circuit controller RRV918
Y1...Y8	Actuators (thermal valve actuators)
1)	Universal input, can be used for temperature acquisition / digital input
2)	Universal potential-free relay output, can be used for mains or low-voltage



# Dimensions

Dimensions in mm

